

Meeting the Readiness Challenge

Mobile Solution for the Warfighter



Sharon Blake – SAP

Bill Sidebottom – SAP

Alan Johnston - Mimosa

Topics to be Covered



- **Mobile Engine**
- **Integrating Weapon System Platforms & SAP**
- **Integrating IETMs and SAP**
- **Standard Format for Data Exchange**

Topics to be Covered



- **Mobile Engine**
- **Integrating Weapon System Platforms & SAP**
- **Integrating IETMs and SAP**
- **Standard Format for Data Exchange**

mySAP Mobile Business solutions enable SAP to offer innovative and successful end-to-end business solutions for mobile devices.

Mobile Access

- Focus on the entire user experience to advance adoption, reduce training costs, and optimize gains.

Mobile Applications

- Provide tools which span multiple systems and include a broad range of processes, information and knowledge.

Mobile Technology

- Technology infrastructure to support applications in connected and disconnected environments.

mySAP Mobile Business

mySAP Mobile Business Architecture

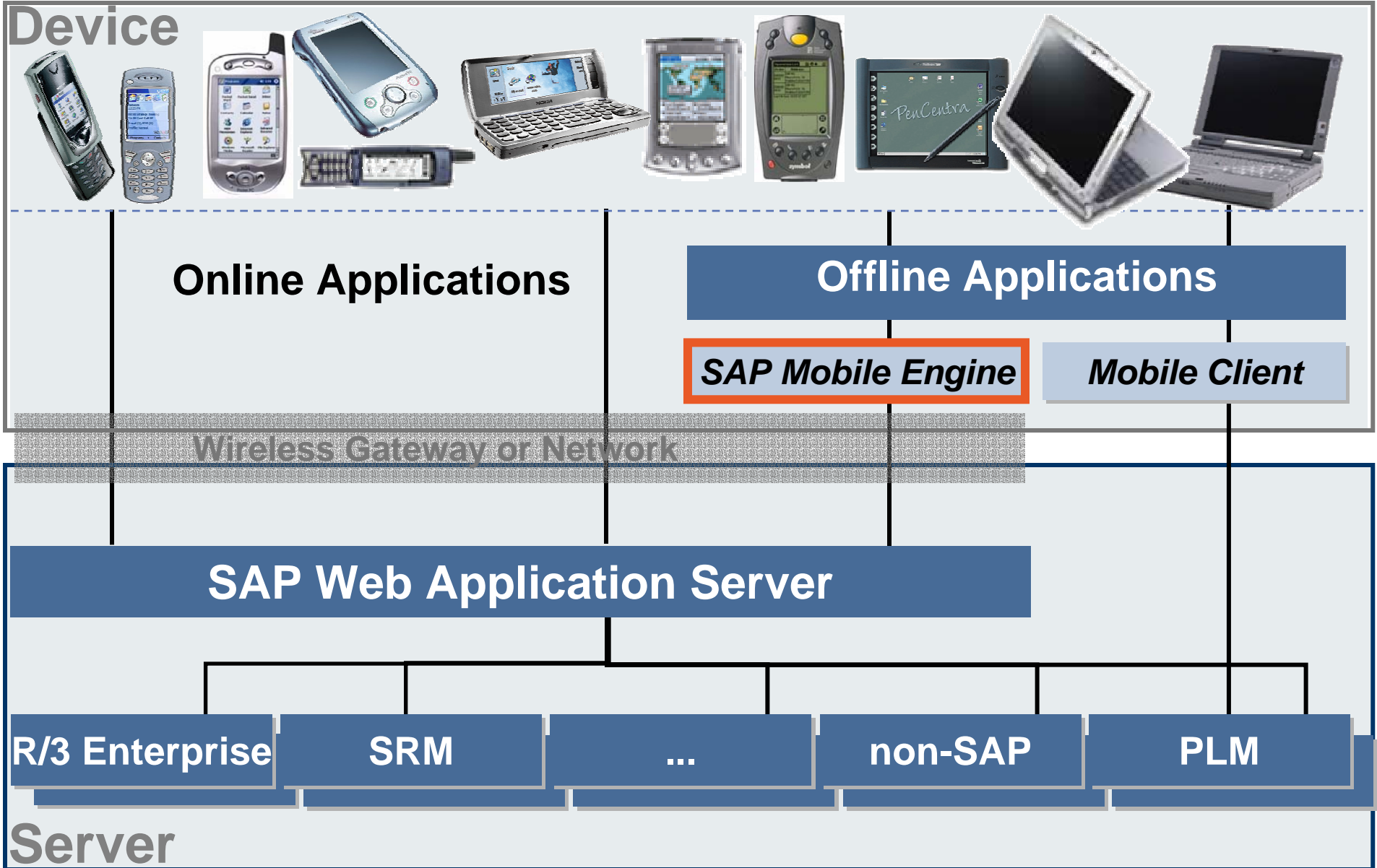

- platform-independent **runtime** for mobile applications
- strong mechanism for **data synchronization** between mobile devices and ERP backends
- central **administration & deployment** tool for mobile applications

- **Platform-independent**

- Java-based framework
- J2SE and J2ME support
- Local browser or Java UI

- **Open standard programming models for all situations**

- JSP 1.1
- pure Java (AWT, J2ME midlets)

- **Extensive toolkit**

- Specialized API for mobile application development
- Native driver support (scanner, printer, infrared etc.)
- Database support

- **Ensured, encrypted, compressed data transfer**
- **Support of any connection type**
 - GSM / GPRS
 - WLAN / LAN
 - Cradle
- **Two synchronization modes**
 - Generic Synchronization
 - Smart Synchronization
- **Multiple backend support**
 - regardless of SAP release
 - SAP and 3rd party systems

Smart Synchronization vs. Generic Synchronization

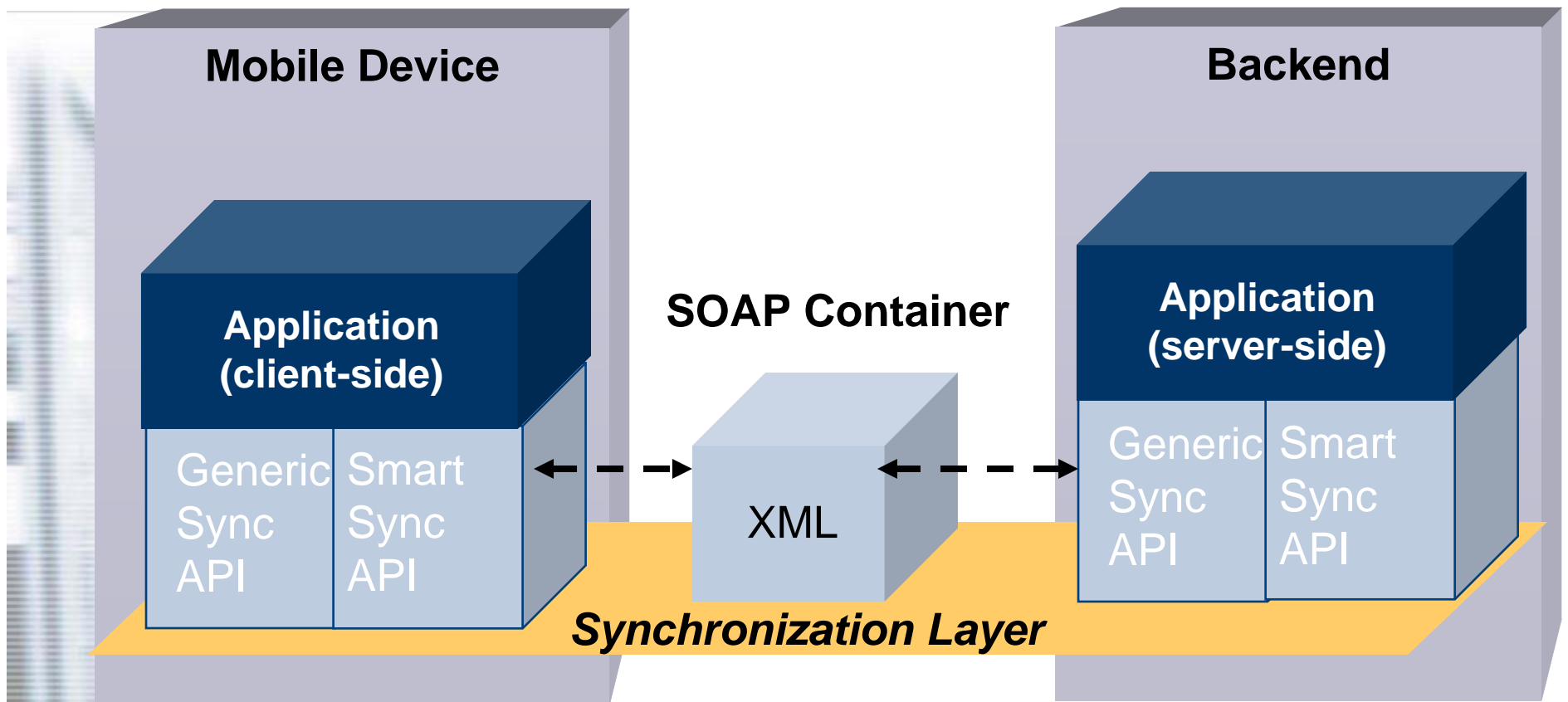

- **Generic Synchronization**
 - Call of any SOAP request or SAP function module
- **Smart Synchronization**
 - Full-blown data replication middleware

Topics to be Covered



- **Mobile Engine**
- **Integrating Weapon System Platforms & SAP**
- **Integrating IETMs and SAP**
- **Standard Format for Data Exchange**

Condition of Weapon System drives Logistic Requirements & Responsiveness

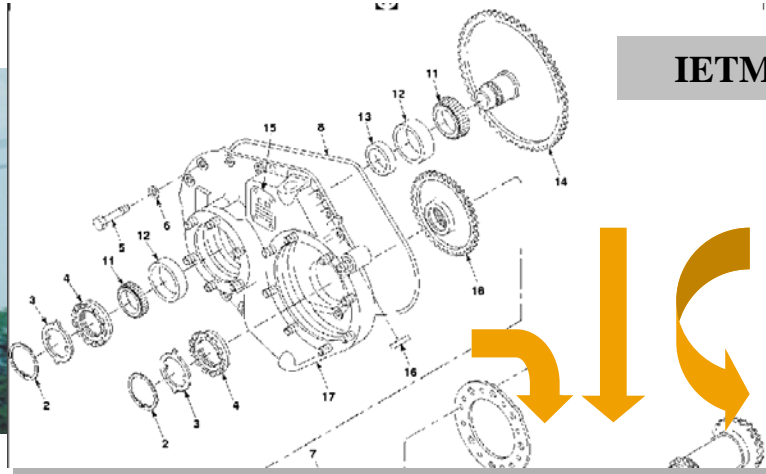

IETM



Equipment exchange

AVUM

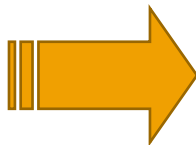

EAGLE THUNDER
159th Aviation Brigade (Assault)

Welcome, David Lincourt

myDefense Collaboration Home

Theaters Operations **Weapon Systems** Readiness Intelligence Quality of Life

My Weapon Systems Browse Weapon System

Select functional location:
10 Functional locations

Functional Location

- 101
- 6911424
- 6913648
- 6914214
- 6915212

1/2

[Refresh the favorite list](#)
[Add new functional location](#)
[Delete marked entry from list](#)
[Select all](#)
[Deselect all](#)

Functional Location 101
101 > 101-159 > 101-159-006 > 101-159-006-A > 101-159-006-A.01

Hier	Type	Number	Description	Doc
01	01	60-44301	BlackHawk - UH-60A Tail 44301	01
02	01	60-56990	BlackHawk - UH-60A Tail 56990	01
03	01	60-67268	BlackHawk - UH-60A Tail 67268	01

1/1

Display Documents
Functional Location 60-44301:
1 Documents / 1 Originals

Document

- [OPERATOR S AND CREWME...](#) PDF
- [CREWME...](#) PDF

1/1

Create Notification
For Functional Location
60-44301
Priority PD 03

Create

Weapon System Master Data
Functional Location 60-44301

Name	Description
Functional location	60-44301
Description of functional location	BlackHawk - UH-60A Tail 44301
Location structure indicator	Aircraft - Model & Tail (A/C)
Location category	Technical system - standard (M)
Planning Plant	Orlando (3700)
Plant	Orlando (3700)

Stock query

Manufacturing Part Number: 3421
Description: Fuel System-Engine, LH

Material Number	Available	Unit
3421	5	pieces
2123	0	pieces

part availability

Smart Distribution Scenario

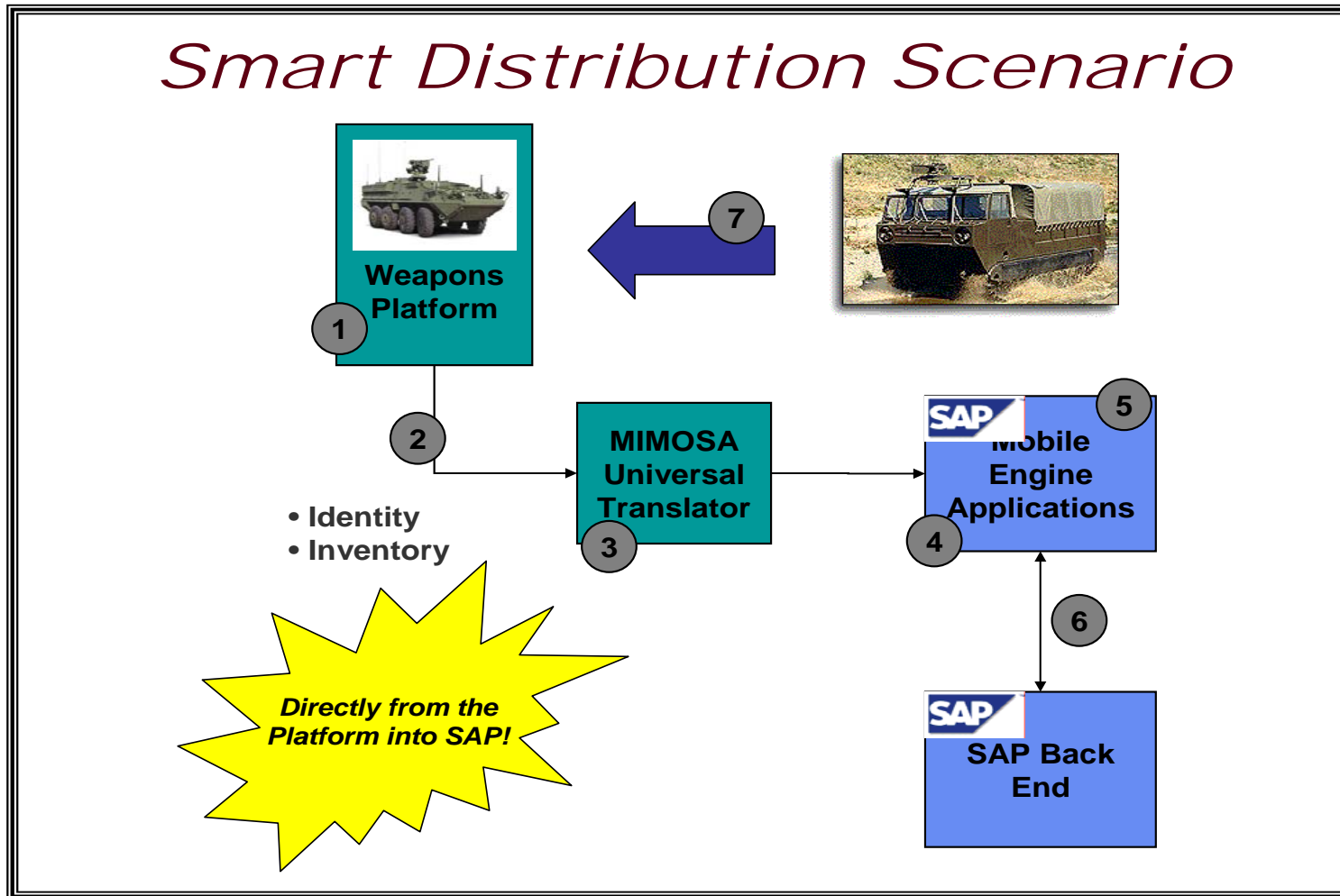

Communication between the W/S and SAP

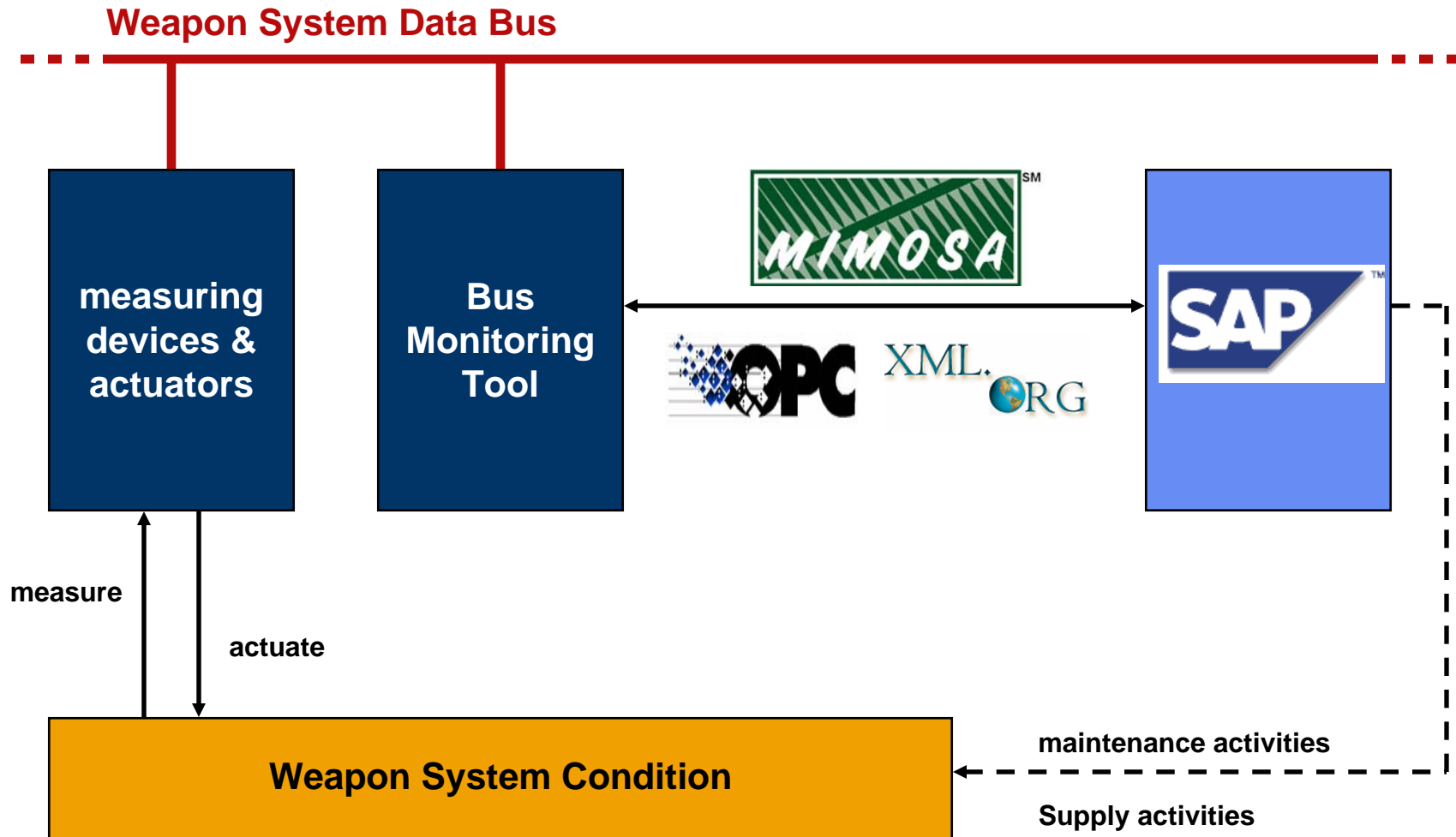

Who Is MIMOSA?

Our Sponsor Level Members



Mission: Develop and Encourage Adoption of Open Information Standards For Operations & Maintenance

MRO Technology Integration Summary

Availability to Promise Order Guarantees Optimize Supply Chain Optimize TCO/ROA Decisions

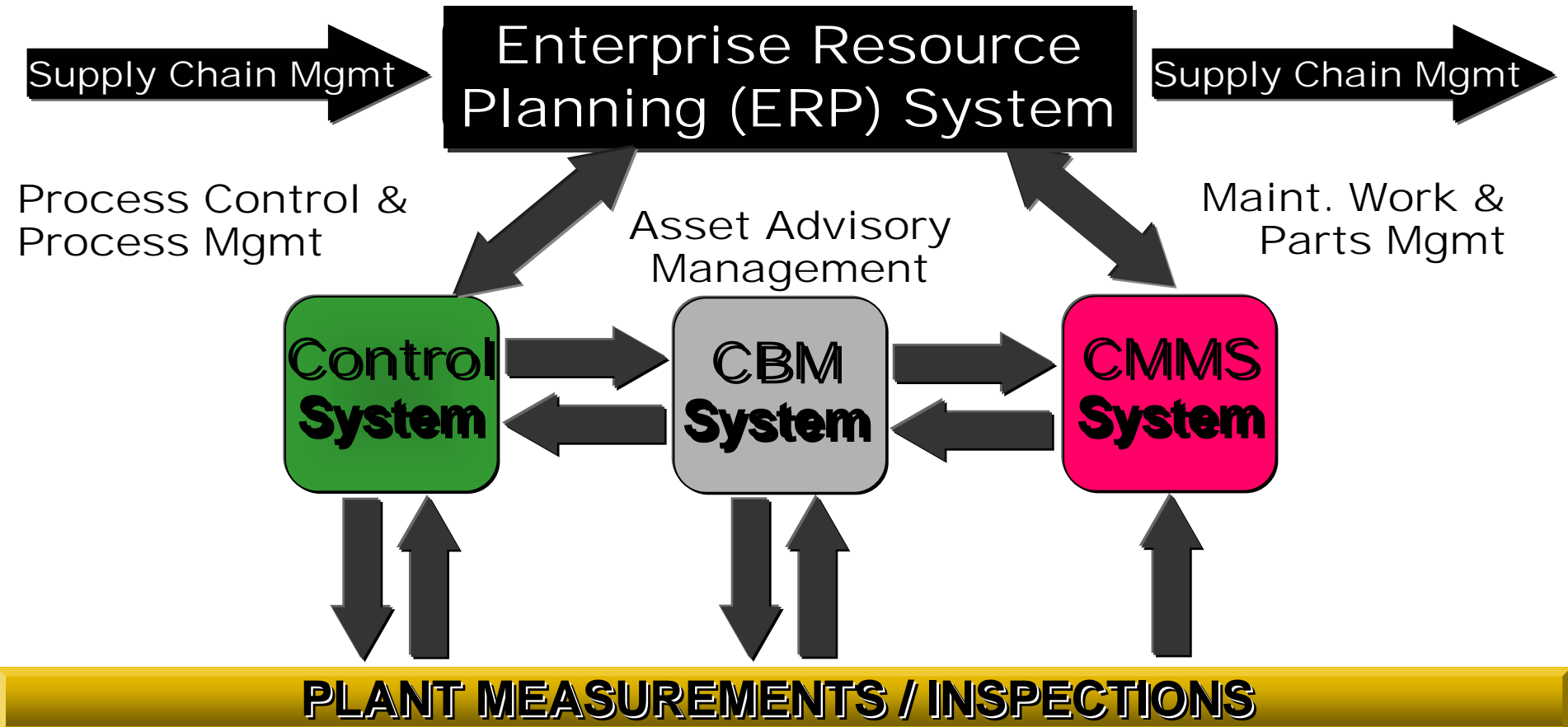

PLANT MEASUREMENTS / INSPECTIONS																				
Operation Field Input	Smart Machines & Xducers	Control Device Monitoring		Portable Device Monitoring			On-line Surveillance Monitors			On-Line Protection Monitors		On-line Transient Monitor		Sample Monitoring						
		Smart Valves & Field Devices	PLC	Vibration	Process	Oil Analysis	Thermography	Electrical	Shaft Displacement	Casing Vibration	Process	Electrical	Shaft Displacement	Shaft Position	Casing Vibration	Process	Shaft Displacement	Casing Vibration	Process	Oil Particle

MIMOSA Collaboration For OpenO&M™

Army CECOM Collaborative Telemaintenance Project

NAVSEA-TOSA Program

- MIMOSA Member
- Joint Services Demonstration Project Under Discussion

National Institute of Building Sciences (NIBS)

- Reciprocal Memberships
- Facilities Management Standard Development
- Joint Demonstration Project Under Discussion



Technical Committee 108
Sub-Committee 5



Accredited Standards
Committee S2



+



= OpenO&M™

CBM+ Information Architecture Concept

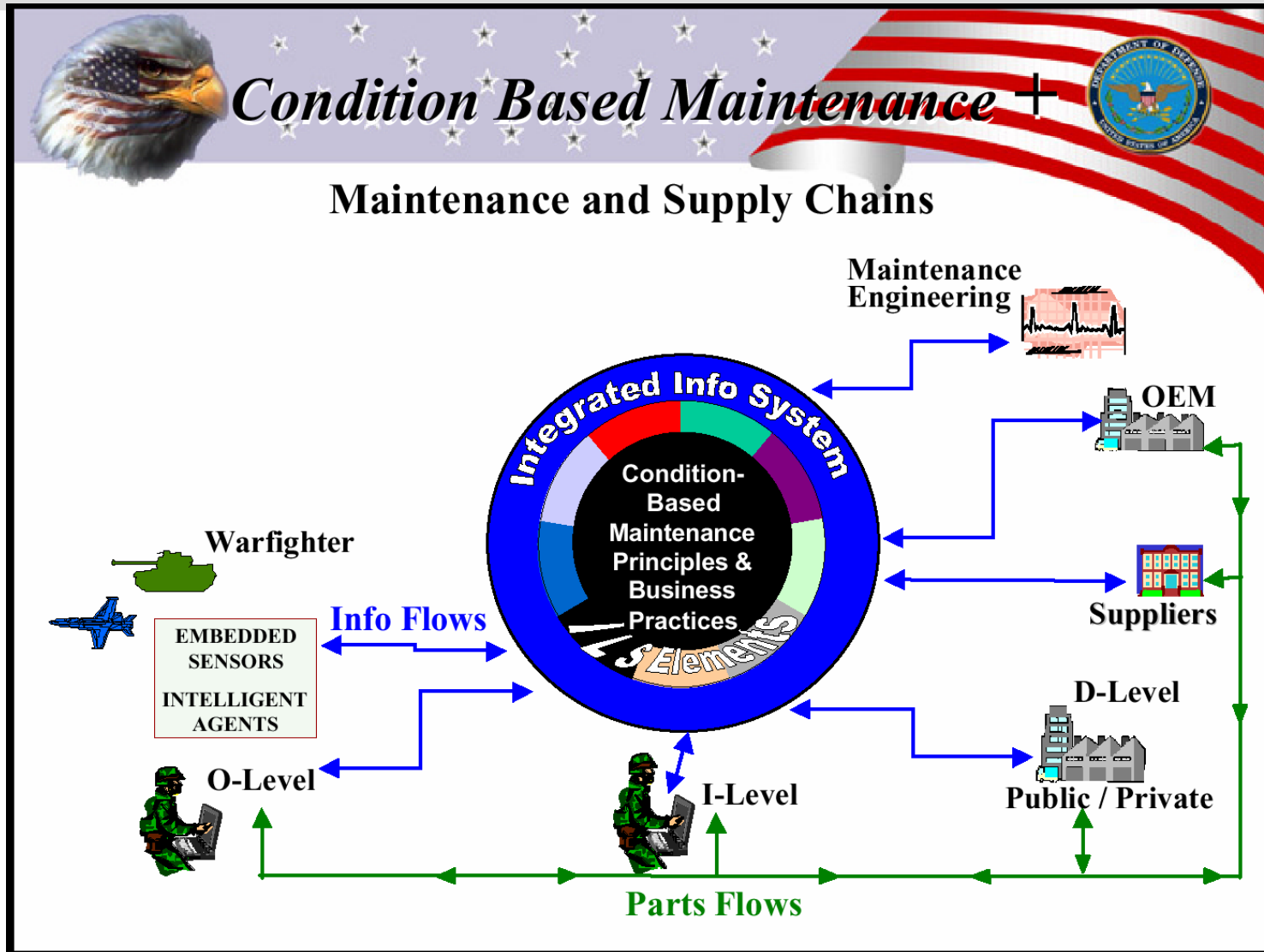

Excerpt From: Future Logistics Enterprise

The Honorable Diane K. Morales

Deputy Under Secretary of Defense

(Logistics and Materiel Readiness)

Army Platform Information Exchange Maps

MIL STD 3008

+

MIMOSA

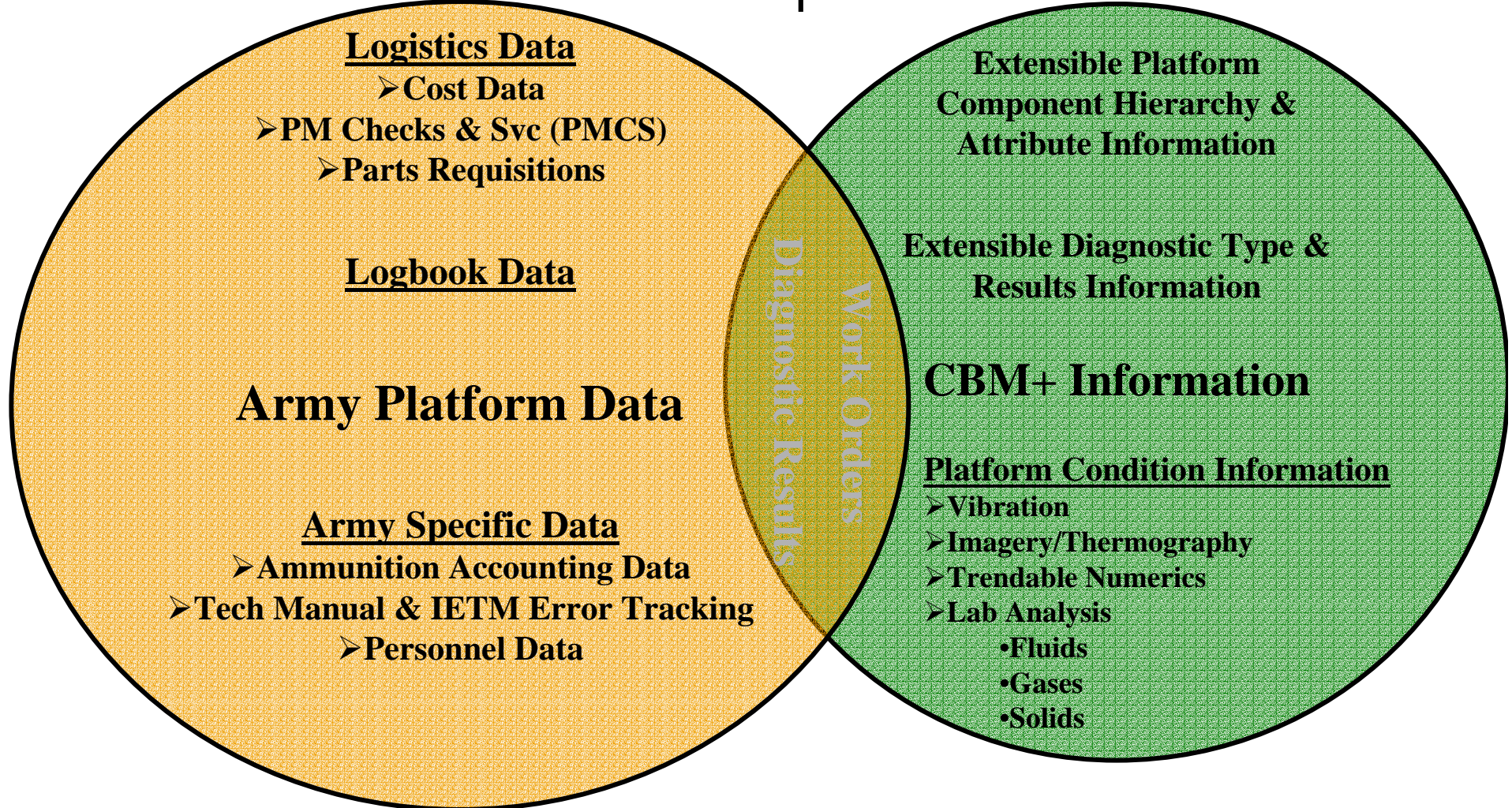

= Army Platform Information Solution

OpenO&M™ Technologies

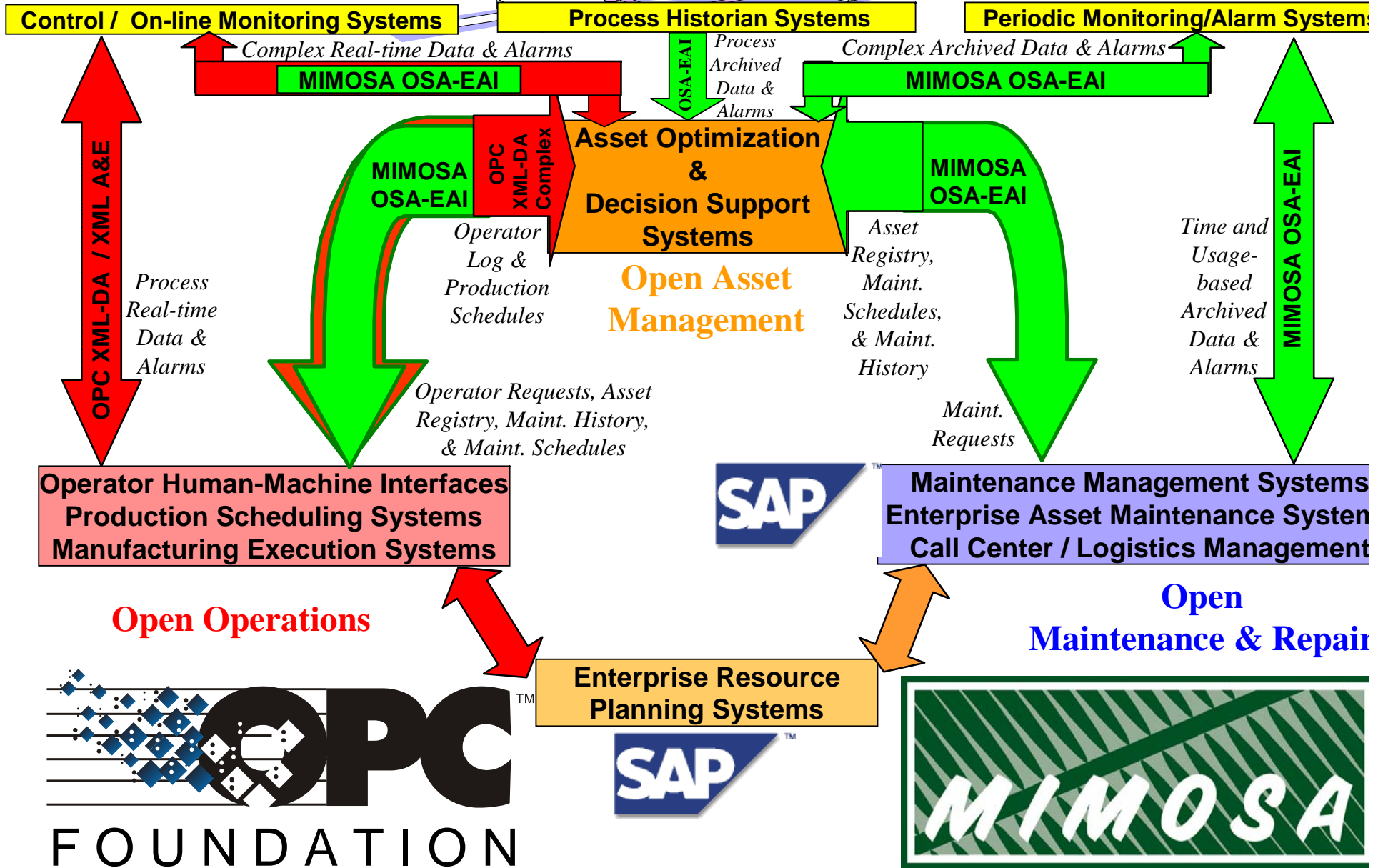
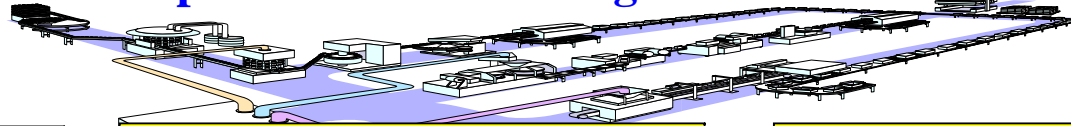

- No part of this publication may be reproduced or transmitted in any form or for any purpose without the express permission of SAP AG. The information contained herein may be changed without prior notice.
- Some software products marketed by SAP AG and its distributors contain proprietary software components of other software vendors.
- Microsoft®, WINDOWS®, NT®, EXCEL®, Word®, PowerPoint® and SQL Server® are registered trademarks of Microsoft Corporation.
- IBM®, DB2®, DB2 Universal Database, OS/2®, Parallel Sysplex®, MVS/ESA, AIX®, S/390®, AS/400®, OS/390®, OS/400®, iSeries, pSeries, xSeries, zSeries, z/OS, AFP, Intelligent Miner, WebSphere®, Netfinity®, Tivoli®, Informix and Informix® Dynamic Server™ are trademarks of IBM Corporation in USA and/or other countries.
- ORACLE® is a registered trademark of ORACLE Corporation.
- UNIX®, X/Open®, OSF/1®, and Motif® are registered trademarks of the Open Group.
- Citrix®, the Citrix logo, ICA®, Program Neighborhood®, MetaFrame®, WinFrame®, VideoFrame®, MultiWin® and other Citrix product names referenced herein are trademarks of Citrix Systems, Inc.
- HTML, DHTML, XML, XHTML are trademarks or registered trademarks of W3C®, World Wide Web Consortium, Massachusetts Institute of Technology.
- JAVA® is a registered trademark of Sun Microsystems, Inc.
- JAVASCRIPT® is a registered trademark of Sun Microsystems, Inc., used under license for technology invented and implemented by Netscape.
- MarketSet and Enterprise Buyer are jointly owned trademarks of SAP AG and Commerce One.
- SAP, SAP Logo, R/2, R/3, mySAP, mySAP.com and other SAP products and services mentioned herein as well as their respective logos are trademarks or registered trademarks of SAP AG in Germany and in several other countries all over the world. All other product and service names mentioned are trademarks of their respective companies.
- MIMOSA Collaboration For OpenO&M™